

# AC DRIVE SOFTWARE TOOLS

PORTFOLIO OF SOFTWARE TOOLS FOR AC DRIVES

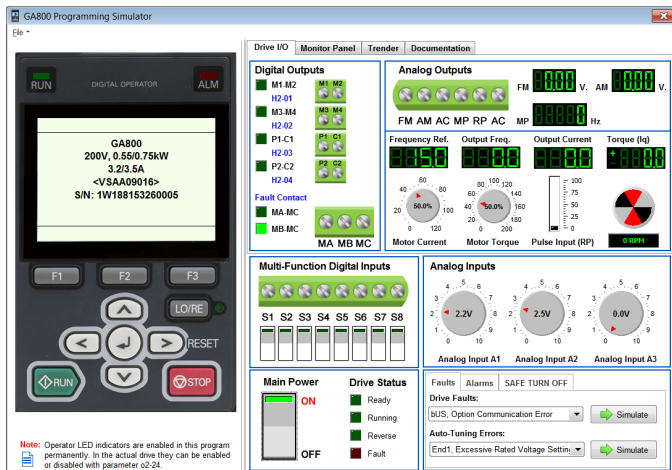

# MAKING IT EASY FOR YOU

Did you know that Yaskawa America has a variety of software tools to support Yaskawa variable frequency AC drives? From selection, to maintenance and replacement, Yaskawa software is driven by user needs and designed to make your life easier.

Yaskawa has years of industry and application expertise built into Yaskawa AC drives that make them suitable for most any application. This history of providing high quality AC drives is also paired with great software. This portfolio provides a simple, consolidated overview of Yaskawa software tools that you can choose from to meet your specific needs.

## DRIVEN BY USER NEEDS

Yaskawa software contains useful features and refinements that have been continuously improved with years of customer feedback. Our customers are our partners, and many have experienced the top-tier response provided by Yaskawa's support and development teams when resolving issues or replying to technical inquiries. Yaskawa software is truly driven by all types of customers working in a myriad of roles throughout the industry.

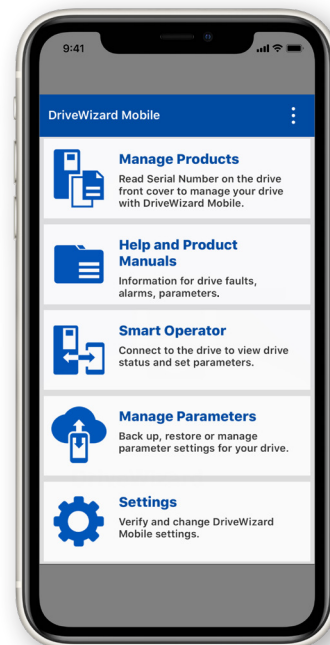

## PURPOSEFUL, PRACTICAL, AND USEFUL

Whether your purpose is to specify, quote, start up, maintain, or troubleshoot; Yaskawa has practical software solutions to simplify your tasks and give you the results you need to compete and be effective with Yaskawa products. This document introduces you to Yaskawa's software for AC drives and provides an index so you can find and try tools that interest you. We'll also discuss a few key features of the popular DriveWizard PC tool to provide a sense for some of the most useful features.

Yaskawa software tools take a practical, intuitive approach to getting the job done. We are constantly evolving our software to add new product compatibility and features requested by our users.

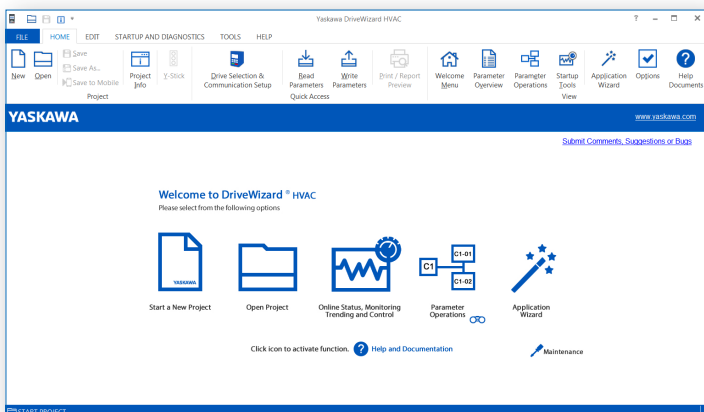

# PRODUCT COMMISSIONING

## COMMISSIONING, PROGRAMMING, MONITORING

### DriveWizard®

The DriveWizard support tool is an innovative Windows-based PC program consisting of a user-friendly interface that allows you to commission, program and diagnose Yaskawa AC drives in a quick and easy way. DriveWizard provides highly-accessible tools for viewing, manipulating, and exchanging data with the drive. Data can be retrieved, changed, stored, and graphed. DriveWizard makes retrofits simple with its Drive Conversion utility that easily converts settings from an older series Yaskawa drive to a newer series Yaskawa drive. The iQpump Edition of DriveWizard offers an easy to use pump system setup wizard for Simplex and Multiplex applications.

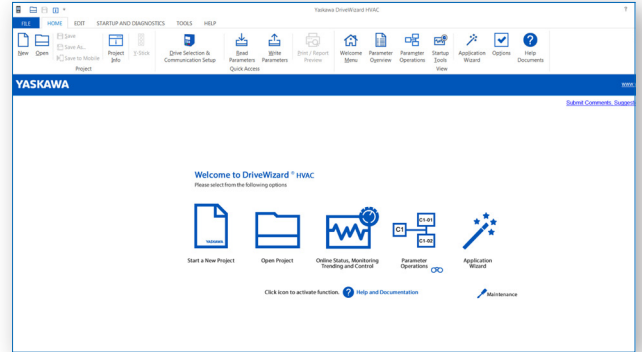

### Applicable Drive Series:

HV600, Z1000, Z1000U, E7, GA800, GA500, A1000, P1000, V1000, V1000-4X, J1000, U1000, G7, F7, P7, AC7, G5, R1000, D1000, L1000A, L1000E, MV1000

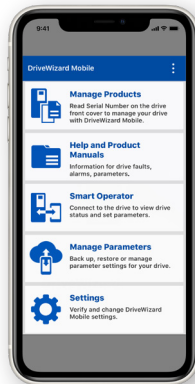

### DriveWizard Mobile with Yaskawa Drive Cloud

DriveWizard Mobile is the mobile application version of Yaskawa's DriveWizard PC Tools. With DriveWizard Mobile, you can start-up, adjust and monitor Yaskawa's new AC drives with your smartphone or tablet. Use DriveWizard Mobile to backup, store and retrieve your drive settings locally or to your personal Yaskawa Drive Cloud™ account.

Connect your mobile device with the optional Yaskawa BLUETOOTH™ keypad for a wireless experience. Alternatively, connect your smartphone or tablet with a USB-OTG cable and program your drive without main power! The drive is equipped with a female Type B Mini-USB port.

DriveWizard Mobile is available from the App Store and Google Play.

### Applicable Drive Series:

GA800, GA500, HV600, HV600 Bypass



**Easy operation** using your smartphone.

Even **easier** operation when linked to the **cloud**.

Check **drive status** right away at any time **during operation**.

**Operate** the drive and change parameter **easily**.

Google Play and the Google Play logo are trademarks of Google LLC.  
 Apple and Apple logo are trademarks of Apple Inc. registered in the US and other countries.  
 The App Store is a service mark of Apple Inc. iOS trademarks are used under the license of Cisco USA.  
 The Bluetooth® word mark and logos are registered trademarks owned by Bluetooth SIG, Inc.

# PREDICTIVE TOOLS

## ENERGY SAVINGS

### Energy Savings Predictor

Controlling applications with Yaskawa VFDs saves energy and reduces operating costs.

The Energy Savings Predictor accurately predicts the energy saved when Yaskawa VFDs replace conventional mechanical control processes. The software provides a payback analysis that predicts Carbon Footprint / Emissions with a Calculation Module that includes CO<sub>2</sub> Emissions.

The resulting report is extremely useful, as it provides a clear before and after analysis. The software includes a project management module to support single or multiple systems of different sizes. Simply input utility information and system specifics to generate a professional report for your purpose. Energy Savings Predictor is available at no cost.

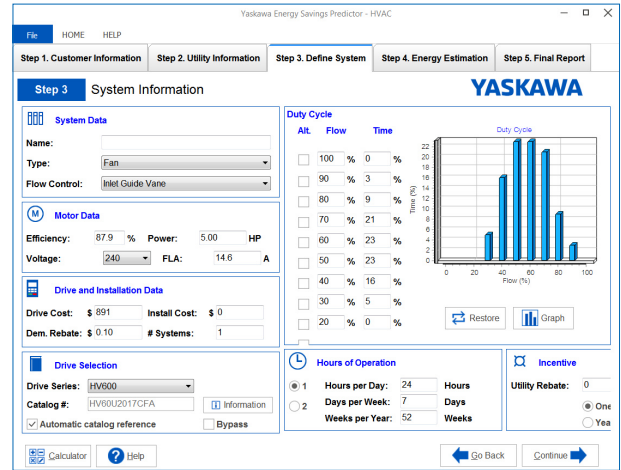

### Applicable Drive Series:

HV600, Z1000, Z1000U, GA800, GA500, P1000, U1000, iQpump1000, iQpumpMicro, U1000 iQpump, MV1000

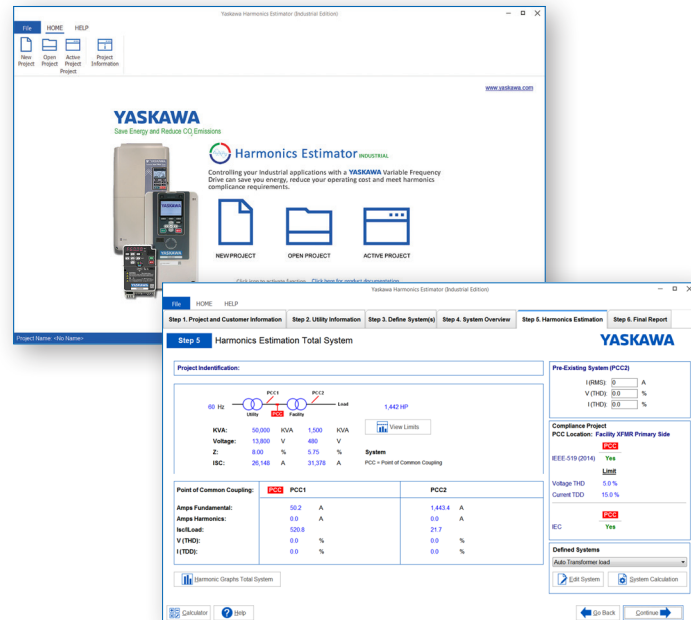

## HARMONICS

### Harmonic Estimator

This software allows you to estimate harmonics at the Point of Common Coupling (PCC) utilizing the drive to select the proper mitigation solution. It is fully optimized, including a navigation and project management module that allows you to create projects containing multiple systems (6, 12 and 18 pulse) of different sizes. The new advanced reporting module allows you to customize the final report from a single summary page to a full multi-page report with selectable harmonics graphs.

### Applicable Drive Series:

HV600, Z1000, Z1000U, GA800, GA500, U1000, A1000, P1000, iQpump Micro, iQpump1000, U1000iQpump

# PRODUCT SIMULATION

## APPLICATION AND PROGRAMMING SIMULATORS

### Programming Simulator

The Programming Simulator provides a realistic simulation of the programming and operation of many Yaskawa VFDs. All major functions of the drives are simulated by these PC tools with the addition of I/O, trending, and diagnostic operations. The software has an integrated automatic update function that allows for updating the program when connected to the internet.

#### Applicable Drive Series:

HV600, Z1000, Z1000U, GA800, GA500, A1000, P1000, U1000, V1000, J1000

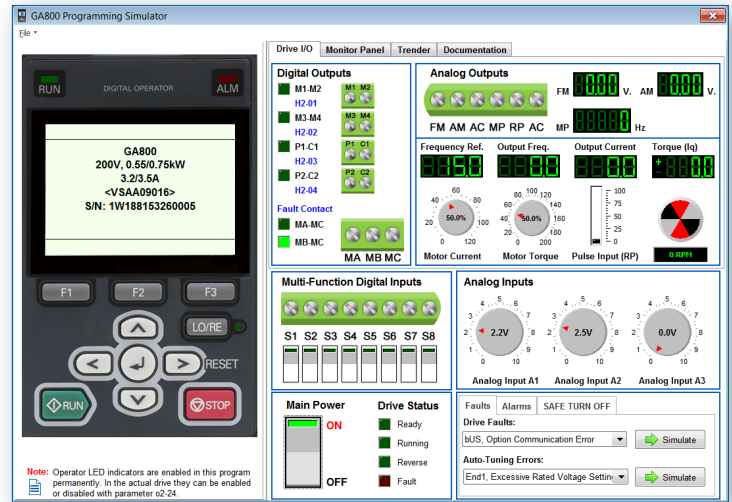

### Application Simulator - iQpump

This software simulates typical pump applications for the iQpump1000 or iQpump Micro drive. Select from six commonly used pumping applications ranging from simplex to triplex. Each real-life iQpump1000/iQpump Micro application supports the most commonly used features.

The software is extremely easy to use and automatically presets parameters for the selected application. The 200 V and 400 V class iQpump1000 drives are supported up to 1000 HP (1200A). iQpump Micro drives in the 240 V and 480 V class are also supported. With the built-in automatic update function it is easy to upgrade the software when new applications and functions become available. Supported applications: Constant Pressure Simplex, Constant Pressure Submersible, Pump Down Level Simplex, Constant Pressure VTC, Duplex Pump, Triplex Pump

#### Applicable Drive Series:

iQpump1000, iQpump Micro

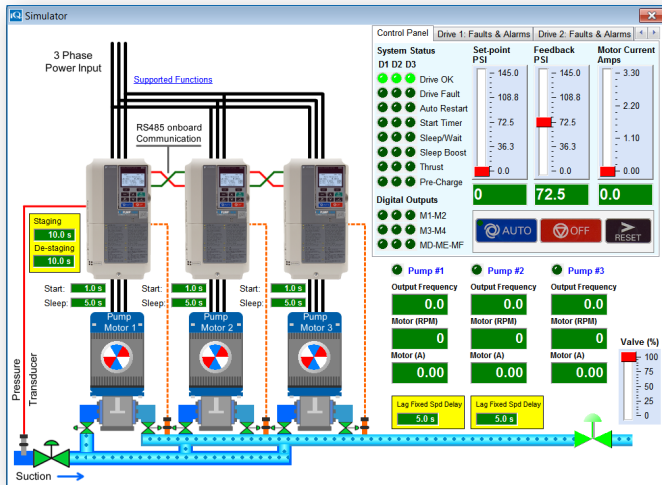

# PRODUCT SELECTION

## PRODUCT SELECTION

### Product Selectors

Quickly and easily select the drive you need for your application. The tool walks you through a few basic questions and provides you recommendations by product series and catalog code.

Selecting a drive for your application should not be complex. This is why Yaskawa's Product Selector programs are designed to be intuitive and to give you what you want – the correct drive for your application.

Through a series of simple questions (motor voltage, motor HP), it provides a list of recommended drives that are suitable for your application; thus enabling you to compare and contrast drives in order to better narrow your search.

### Applicable Drive Series:

GA800, GA500, P1000, U1000, V1000, A1000 (600 V)

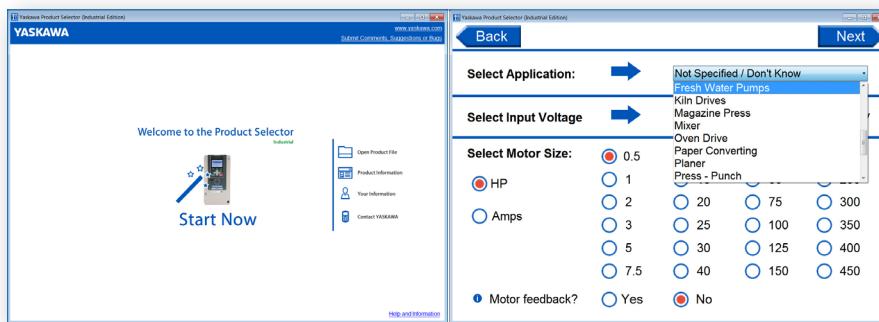

# CUSTOMIZATION

## CUSTOM PROGRAMMING

### DriveWorksEZ®

DriveWorksEZ® is a software tool that provides the means to create custom logic and mathematic functionality inside Yaskawa AC drives. This functionality is built into Yaskawa AC drives and at no extra charge. Simply create application programs by arranging function block icons in a visual flow chart. Total drive and machine control are only a few mouse clicks away. User-friendly program monitoring is included for fast, easy start-up and troubleshooting. DriveWorksEZ provides a built-in PLC, allowing the user to customize and adapt Yaskawa AC drives to their machine needs in a fast and intuitive manner.

DriveWorksEZ® is available in Standard or Professional versions.

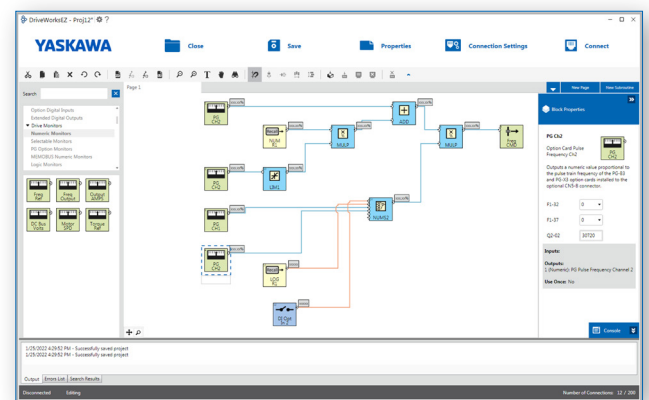

### Applicable Drive Series:

HV600, V1000, GA800, GA500, A1000, V1000 and U1000

# SOFTWARE TOOL INDEX

Software Tool	Available Versions	Applicable Products
DriveWizard	DriveWizard Mobile - App Store, Google Play	GA800, GA500, HV600
	DriveWizard Industrial - SW.DW.30	GA800, GA500, A1000, P1000, V1000, V1000-4X, J1000, U1000, G7, F7, P7, AC7, G5, R1000, D1000
	DriveWizard HVAC - SW.DW.40	HV600, Z1000, Z1000U, E7,
	DriveWizard iQpump® - SW.DW.60	U1000 iQpump, iQpump1000, iQpumpMicro
	DriveWizard iQRise® - SW.DW.50	L1000A, L1000E
	DriveWizard MV - SW.DW.70	MV1000
Product Selector	Industrial Product Selector - SW.PS.01	GA800, GA500, P1000, U1000, V1000, A1000 (600V)
Energy Savings Predictor	Energy Savings Predictor Industrial - SW.ESP.10	GA800, GA500, P1000, U1000
	Energy Savings Predictor HVAC - SW.ESP.06	Z1000, Z1000U, HV600
	Energy Savings Predictor iQpump® - SW.ESP.13	U1000 iQpump, iQpump1000, iQpumpMicro
	Energy Savings Predictor MV - SW.ESP.14	MV1000
Harmonics Estimator	Harmonics Estimator Industrial - SW.HE.03	GA800, GA500, U1000, A1000, P1000
	Harmonics Estimator HVAC - SW.HE.06	Z1000, Z1000U, HV600
	Harmonics Estimator iQpump® - SW.HE.14	U1000 iQpump, iQpump1000, iQpumpMicro
Programming Simulator	Programming Simulator industrial - SW.AFD.10	GA800, GA500, A1000, P1000, U1000, V1000, J1000
	Programming Simulator HVAC - SW.HVAC.01	Z1000, Z1000U, HV600
Application Simulator	Application Simulator iQpump® - SW.iQp1000.01	U1000 iQpump, iQpump1000, iQpumpMicro
DriveWorksEZ®	DriveWorksEZ® - SW.DWEZ.10	HV600, V1000, GA800, GA500, A1000, V1000 and U1000

